

Rebend connection
Rückbiegeanschluss
Stekkenbakken
Łączniki zbrojeniowe
Caixa de ferros de espera
Stykovací výztuž

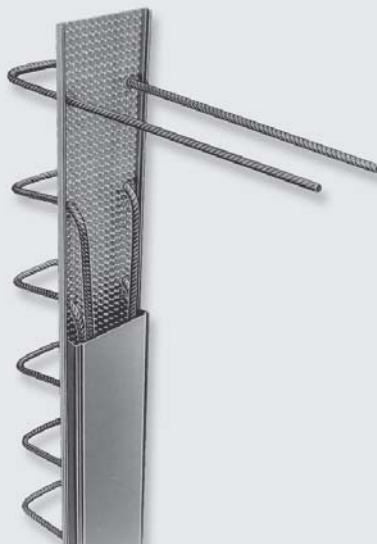

Assembly Instructions • Montageanleitung • Montagehandleiding • Instrukcja montażu
Instruções de Montagem • Montážní návod



HALFEN
YOUR BEST CONNECTIONS

1. Before Concreting: Fixing to the formwork

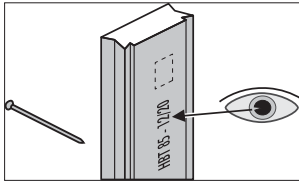

Pay note the type reference number located on the steel cover of the HBT element.

For an explanation of the reference numbers: see brochure ' HBT Technical Product Information'.

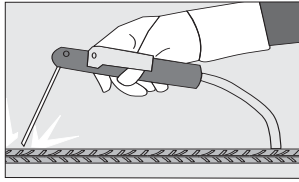

Welding and heat input in the rebend area is forbidden, as welding, even spot welding, can impair material properties. Further welding not in the rebend area must be carried out according to recognized welding regulations and guidelines; these welds are the sole responsibility of the contractor or welder.

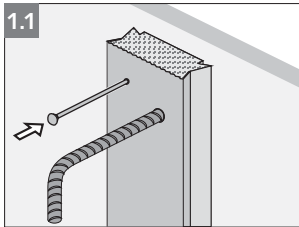

- 1.1** Nail the HBT element according to the reinforcement drawing to the timber formwork at the specified position. Use at least 3 nails per element for fixing. For steel formwork use appropriate fixings, e.g. magnetic fastener.

2. After Concreting and striking the formwork



Caution! Always use safety gloves when pulling out the steel cover. The edges of the steel cover may be sharp.

- 2.1** Remove any concrete stuck to the steel cover by lightly tapping the steel cover with a hammer, as shown in illustration 2.1.

- 2.2** Hold a rectangular piece of wood lengthwise in the V-shaped recess of the cover. Hit the wood repeatedly with a hammer until the sides of the cover loosen from the concrete.

- 2.3** Use the claw end of a hammer to pierce the pre-punched hole in the steel cover; hook the hammer claw into the hole and lever off the cover.

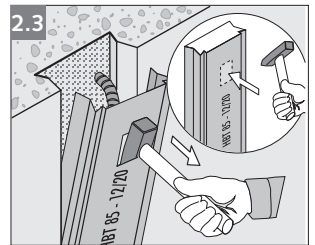
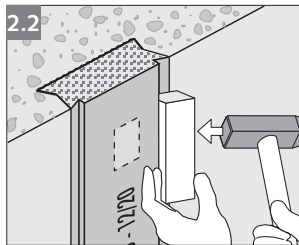
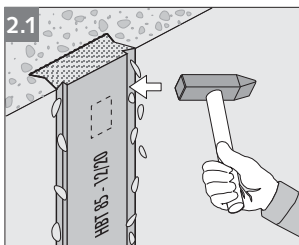

3. Rebending the reinforcement bars

3.1

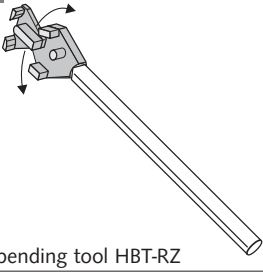

Rebending tool HBT-RZ

3.1 To ensure the reinforcement bars are straightened properly without causing any kinks; use a HALFEN HBT Rebend tool HBT-RZ. There are 2 sizes of rebend tool available, these cover all bar diameters:

Type	for bar diameters:	Order no.
HBT-RZ 8/10	Ø 8 and 10 mm	0064.010-00001
HBT-RZ 10/12	Ø 10 and 12 mm	0064.010-00002

- According to the guidelines in the DBV (German Concrete Association) "Rückbiegen von Betonstahl und Anforderungen an Verwahrkästen nach Eurocode 2", section 3.2.(4) rebending bars without an appropriate tool is not permitted.
- Do not rebend at temperatures below - 5°C.

3.2

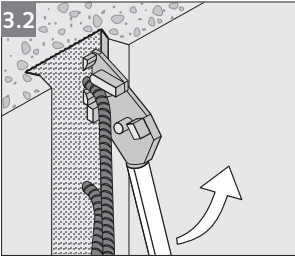

3.2 Apply the HBT bending tool to the reinforcement bar.

3.3

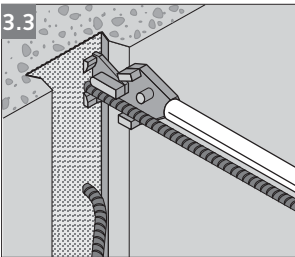

3.3 Using both hands pull the lever of the HBT rebend tool smoothly in an upwards motion until the reinforcement bar is perfectly straight without any kinks. Repeat for all HBT element bars. The profiled steel casing remains in the concrete.

3.4

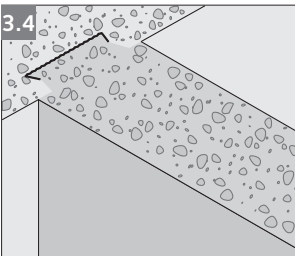

3.4 After pouring the next concrete section the steel casing of the HBT element is entirely encased in concrete and is perfectly protected against corrosion.



Note! The steel cover is recyclable scrap metal, please dispose of in a responsible manner

1. Vor dem Betonieren: Befestigung an der Schalung

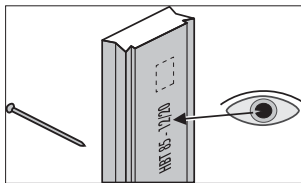

Beachten Sie die Typenbezeichnung, die auf den Blechdeckel des HBT Elements aufgedruckt ist. Erläuterung der Typenbezeichnung: Siehe Broschüre ‚Produktinformation Technik HBT‘.

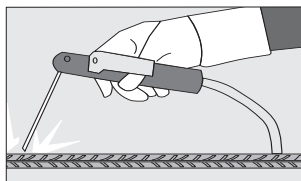

Schweißen, auch Punktschweißen, kann die Materialeigenschaften negativ beeinflussen. Deshalb ist das Schweißen sowie das Eintragen von Wärme im Rückbiegebereich untersagt. Schweißungen außerhalb des Rückbiegebereiches sind nach gültigen Schweißvorschriften durchzuführen und liegen in der Verantwortung des Ausführenden.

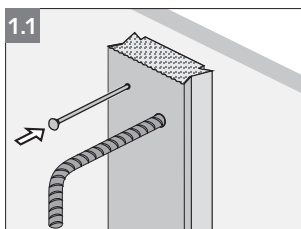

- 1.1** HBT Element gemäß Bewehrungsplan an der vorgesehenen Stelle an Holzschalung nageln. Pro Element mit mindestens 3 Nägeln befestigen. Bei Stahlschalung entsprechend geeignete Befestigungen wie z.B. Magnethalter verwenden.

2. Nach dem Betonieren und Ausschaln: Blechdeckel entfernen



Achtung! Verletzungsgefahr durch die scharfen Kanten des Blechdeckels. Ziehen Sie Schutzhandschuhe an, bevor Sie den Blechdeckel herausziehen.

- 2.1** Entfernen Sie die im Blechdeckel haftenden Betonkrusten, indem Sie mit einem Hammer leicht auf den Blechdeckel schlagen, wie im Bild 2.1 unten.

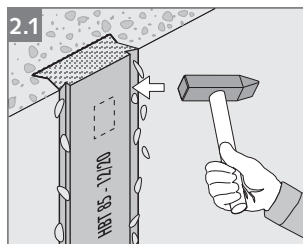

- 2.2** Drücken Sie ein kurzes Kantholz mit der langen Seite in die Längsricke des Blechdeckels. Schlagen Sie mit einem Hammer mehrmals gegen das Kantholz, um die Schenkel des Blechdeckels vom Beton zu lösen.

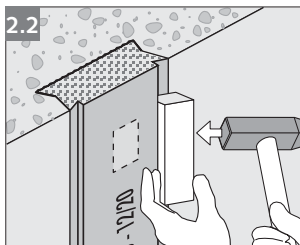

- 2.3** Vorgestanztes Loch im Blechdeckel einschlagen. Benutzen Sie die spitze Seite eines Hammers. Dann Hammer in das Loch im Deckel einhaken und Deckel herausziehen.

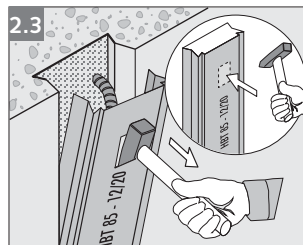

3. Bewehrungsstäbe zurückbiegen

3.1

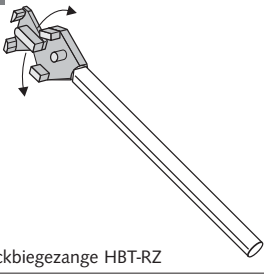

Rückbiegezange HBT-RZ

3.1 Verwenden Sie die HALFEN Rückbiegezange HBT-RZ, um die Bewehrungsstäbe knickfrei zurück- bzw. geradezubiegen. Für die unterschiedlichen Durchmesser der Bewehrungsstäbe gibt es zwei Rückbiegezangen-Typen:

Typ	passend für Stäbe:	Bestell-Nr.
HBT-RZ 8/10	Ø 8 und 10 mm	0064.010-00001
HBT-RZ 10/12	Ø 10 und 12 mm	0064.010-00002

- Das Zurückbiegen ohne geeignetes Werkzeug ist gemäß Merkblatt „Rückbiegen von Betonstahl und Anforderungen an Verwahrkästen nach Eurocode 2“ des DBV, Abschnitt 3.2.(4) nicht zulässig.
- Nicht rückbiegen bei Temperaturen unter - 5°C.

3.2

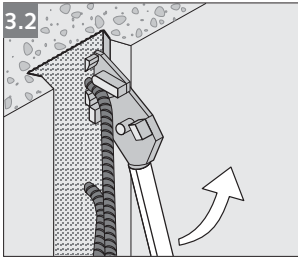

3.2 HBT-Rückbiegezange an den Bewehrungsstab ansetzen.

3.3

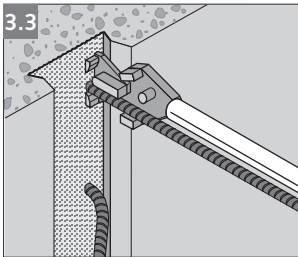

3.3 Ziehen Sie den Hebel der Rückbiegezange mit beiden Händen gleichmäßig nach oben, bis der Bewehrungsstab in die gewünschte Position knickfrei geradegebogen ist. In gleicher Weise nacheinander alle Stäbe des HBT Elements herausbiegen. Der profilierte Gehäuse Rücken des HBT Elements bleibt im Beton.

3.4

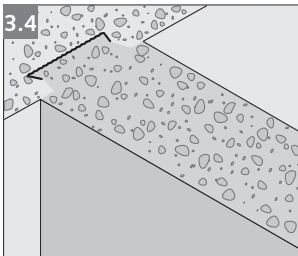

3.4 Nach dem Betonieren des Anschluss-Bauteils ist der im Beton verbliebene HBT-Gehäuserücken vollständig von Beton umschlossen und gegen Korrosion geschützt.



Hinweis! Entsorgen Sie den Blechdeckel als recyclingfähigen Blechsrott.

1. Voor het storten: Bevestiging aan de bekisting

kiwa
gecertificeerd



Opmerking: Op het stalen deksel is het type bak gedrukt. Voor de verklaring van de codering zie onze technische documentatie HBT.

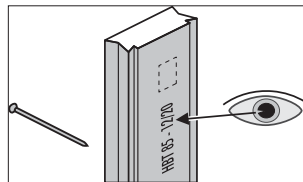

Lassen, alsook het verhitten van het materiaal in de buigzone, is verboden. Lassen, ook hechtlassen, kan de materiaaleigenschappen negatief beïnvloeden. Lassen is alleen toegestaan buiten de buigzone, dient uitgevoerd te worden volgens geldende normeringen en lasvoorschriften en is voor de verantwoordelijkheid van de uitvoerende partij.

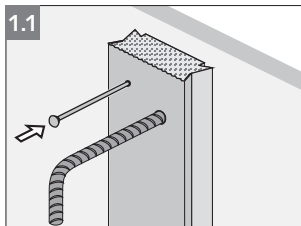
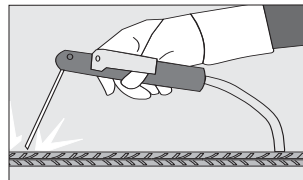

- 1.1** De HBT stekkenbak op de juiste plaats aan de houten bekisting bevestigen. Per element minstens 3 spijkers gebruiken. Bij een stalen bekisting eventueel lassen of een magneethouder gebruiken.

2. Na het storten en ontkisten: stalen deksel verwijderen



Let op! Door de scherpe kanten van het stalen deksel kunnen verwondingen ontstaan. Draag daarom altijd veiligheidshandschoenen bij het verwijderen van het deksel!

- 2.1** Verwijder de aan het deksel gehechte beton, door met een hamer op het deksel te kloppen.

- 2.2** Druk een houten klosje met de lange zijde in de speciale V-groef in het deksel. Sla met een hamer op het houten klosje, doe dit op meerdere plaatsen, tot dat het deksel los komt.

- 2.3** Het voorgestante vierkante plaatje op het deksel met de hamer inslaan. De hamer in het dan ontstane gat haken en het deksel verwijderen.

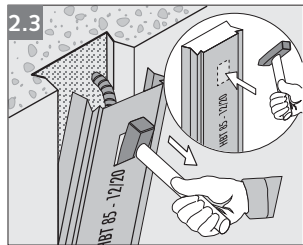
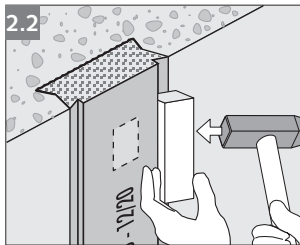
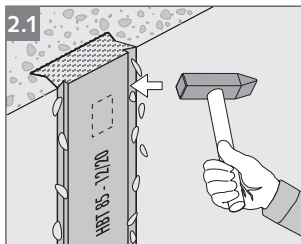

3. Wapeningsstaven terugbuigen

3.1

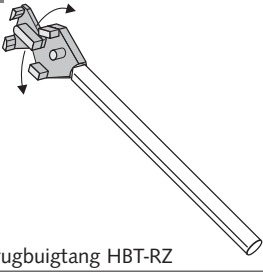

Terugbuigtang HBT-RZ

3.1 Gebruik de HALFEN terugbuigtang HBT-RZ, om de wapeningsstaven zonder te knikken terug te buigen. Voor de verschillende diameters zijn er twee soorten terugbuigtangen:

type	passend op staven:	bestelnr.
HBT-RZ 8/10	Ø 8 en 10 mm	0064.010-00001
HBT-RZ 10/12	Ø 10 en 12 mm	0064.010-00002

- Terugbuigen zonder dit noodzakelijke gereedschap is niet toegestaan.
- Niet terugbuigen bij temperaturen onder -5°C

3.2

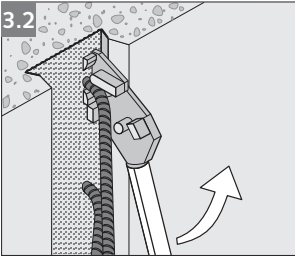

3.2 HBT-terugbuigtang op de wapening zetten.

3.3

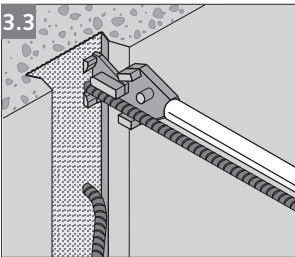

3.3 Druk de steel van de terugbuigtang met beide handen naar boven tot dat de wapeningsstaaf zich zonder knik in de gewenste positie bevindt. Op dezelfde wijze de overige staven uitbuigen. Het geprofileerde gedeelte van het HBT-element blijft in de beton.

3.4

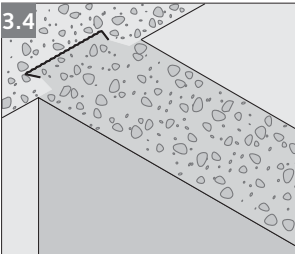

3.4 Na het storten van het aan te sluiten deel is de in de beton achtergebleven bak volledig door beton omsloten en zodanig tegen roesten beschermd.



Opmerking: Het stalen deksel kan bij het te recyclen afval.

1. Przed betonowaniem: mocowanie do szalunku

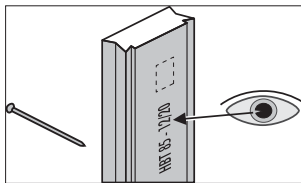

Ważne! Należy zwrócić uwagę na oznaczenie na pokrywie HBT. Wyjaśnienia oznaczeń znajdziecie Państwo w katalogu technicznym HBT. Katalog dostępny jest na naszych stronach www.halfen.pl

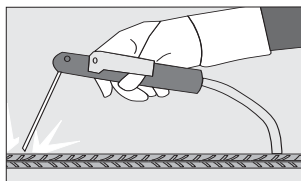

Spawanie, także punktowe, może negatywnie wpływać na właściwości materiału, dlatego w obszarze odginania prętów jest zabronione! Spawanie poza ww. obszarem wykonuje się zgodnie z aktualnymi przepisami i wiedzą techniczną na odpowiedzialność wykonującego.

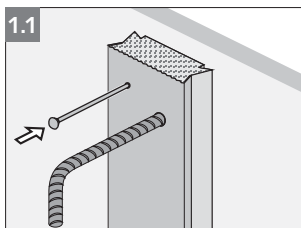

- 1.1** Przybić element HBT do szalunku w miejscu przewidzianym na rysunku zbrojenia. Użyć przynajmniej trzech gwoździ na każdy element. W przypadku szalunku stalowego użyć odpowiedniego mocowania, na przykład: zacisków magnetycznych.

2. Po betonowaniu i usunięciu szalunków: usuwanie blaszanej pokrywy



Ważne! Przy usuwaniu metalowej pokrywy, należy uważać na ostre krawędzie. Prace wykonywać w rękawicach ochronnych!

- 2.1** Usunąć lekkimi uderzeniami młotka resztki betonu z brzozy pokrywy ochraniającej pręty zbrojeniowe, jak pokazano na rysunku 2.1

- 2.2** Przyłożyć krótki, klocek drewniany dłuższym bokiem do wcięcia biegnącego wzdłuż brzozy pokrywy. Uderzać kilkakrotnie w klocek młotkiem, do momentu uwolnienia boków pokrywy obudowy.

- 2.3** Wybić otwór w pokrywie metalowej uderzając ściętą częścią młotka w nacięty na pokrywie prostokąt. Następnie wsunąć młotek w otwór i zdecydowanym ruchem usunąć pokrywę. Element HBT jest przygotowany do odgięcia prętów zbrojeniowych.

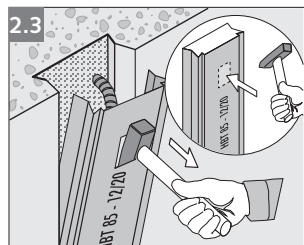
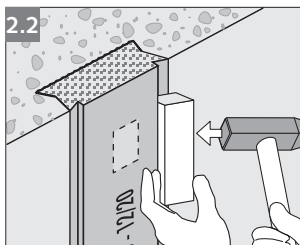
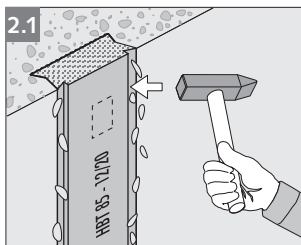

3. Odginanie prętów zbrojeniowych

3.1

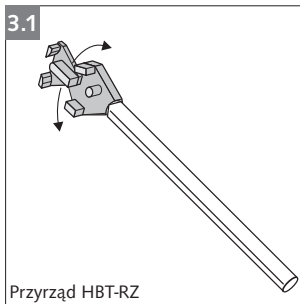

Przyrząd HBT-RZ

3.1 Do odginania i ewentualnego prostowania zbrojenia elementu HBT, należy używać przyrządu HBT-RZ. Ze względu na występowanie różnych średnic zbrojenia odginanego należy używać odpowiedniego typu przyrządu HBT-RZ

Typ	Średnica pręta	Oznaczenie produktu
HBT-RZ 8/10	Ø 8 oraz 10 mm	0064.010-00001
HBT-RZ 10/12	Ø 10 oraz 12 mm	0064.010-00002

- Odginanie prętów bez właściwego przyrządu, według instrukcji „Odginanie prętów zbrojeniowych i wymagania wobec obudów zgodnie z Eurokod 2”(Rückbiegen von Betonstahl und Anforderungen an Verwahrkästen nach Eurocode 2) - DBV, rozdział 3.2.(4) - jest niedopuszczalne.
- Nie odginać prętów przy temperaturze poniżej - 5°C

3.2

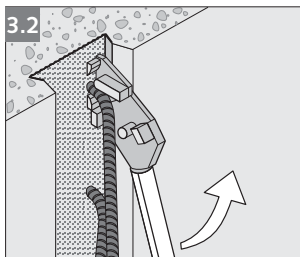

3.2 Nasunąć przyrząd HBT-RZ na pręt wg rysunku.

3.3

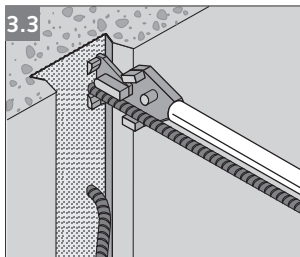

3.3 Ciągnąć równomiernie ramię przyrządu oburącz w górę, aż do całkowitego wyprostowania pręta. Wszystkie pręty zbrojenia elementu HBT odginać po kolei w ten sam sposób. Profilowana obudowa blaszana elementu HBT pozostaje w betonie.

3.4

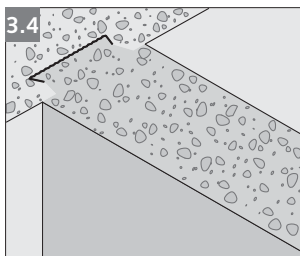

3.4 Po zabetonowaniu kolejnego elementu budowlanego, pozostawiona obudowa elementu HBT zostaje zabezpieczona przed korozją.



Uwaga! Usuniętą pokrywę należy złomować jako odpad blaszany.

1. Antes da betonagem: Fixar na cofragem

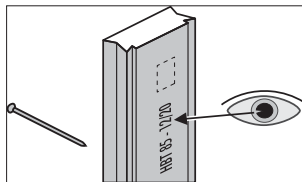

Ter em atenção à designação do tipo de HBT assinalada na tampa da caixa. A designação dos diferentes tipos de HBT encontra-se no catálogo técnico do produto.

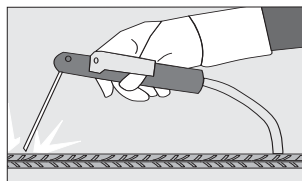

Não deverão ser executadas soldaduras próximas à dobragem dos varões. Fora dessa zona as soldaduras deverão ser executadas conforme regulamentação aplicável sendo da responsabilidade do executante.

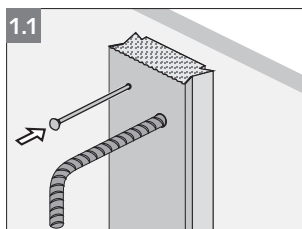

- 1.1** Fixar a caixa de ferros de espera na cofragem na posição adequada em correspondência com a disposição das armaduras pretendida. Fixar a caixa em pelo menos 3 pontos. Para a fixação em cofragem metálica utilizar fixações magnéticas.

2. Remover a tampa da caixa de ferros de espera HBT



Cuidado!

Perigo de ferimento devido às arestas vivas da tampa. Deverão ser utilizadas luvas de protecção aquando a remoção da tampa!

- 2.1** Recorrer a um martelo para remover a camada de betão que aderiu à tampa da caixa, conforme indica a figura 2.1.

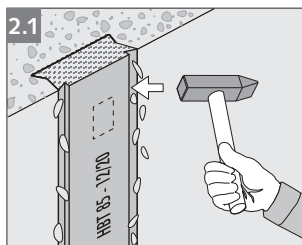

- 2.2** Para descolar as reentrâncias da tampa que aderiram ao betão, utilizar um martelo e bater com uma cunha de madeira, posicionado nas reentrâncias da tampa, conforme ilustra a figura 2.2.

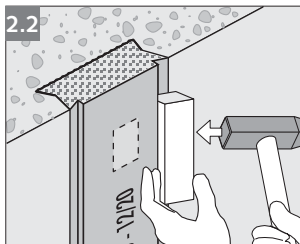

- 2.3** Para remover a tampa da caixa cravar o martelo no furo pré-perfurado existente e puxar conforme indica a figura 2.3.

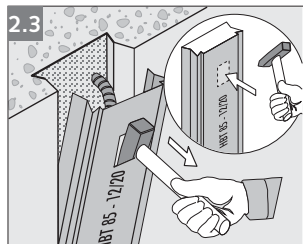

3. Desdobramento dos varões



3.1 O desdobramento dos varões a partir do interior da caixa é efectuado mediante a ferramenta HALFEN HBT-RZ, disponível em 2 diferentes tipos consoante o diâmetro dos varões:

Designação	Diâmetro dos varões	Artigo N°
HBT-RZ 8/10	Ø 8 e 10 mm	0064.010-00001
HBT-RZ 10/12	Ø 10 e 12 mm	0064.010-00002

- De acordo com a DBV (German Concrete Association), „Rückbiegen von Betonstahl und Anforderungen an Verwahrkästen nach Eurocode 2“ secção 3.2. (4), não é permitido o desdobramento dos varões sem uma ferramenta apropriada.
- O desdobramento não deverá ser executado para temperaturas abaixo de -5°C.

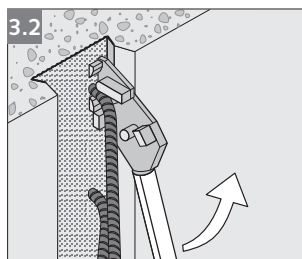

3.2 Encaixar a ferramenta no varão para efectuar o desdobramento.

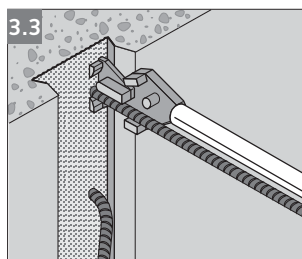

3.3 Com as duas mãos na extremidade da ferramenta (para aumentar o efeito de alavanca) puxar num movimento ascendente até que os varões fiquem na posição horizontal, sem torcer, conforme mostra a figura 3.3. O desdobramento de todos os varões segue o mesmo procedimento. A superfície rugosa da caixa fica no interior do betão.

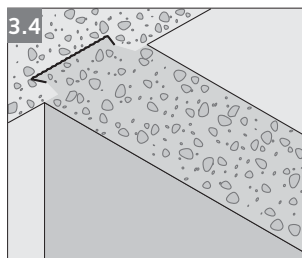

3.4 Após a 2ª betonagem do elemento de betão a ser ligado, caixa de ferro de espera HBT fica no interior do betão estando totalmente protegida contra à corrosão.



Nota: A tampa da caixa é um material reciclável.

1. Před betonáží: upevnění prvku HBT na bednění

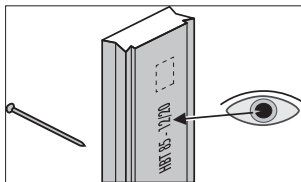

Typové označení prvku HBT je uvedeno na krycím plechu. Jeho vysvětlení naleznete v brožurách „Produktinformation Technik HBT“ a „Katalog HBT“.

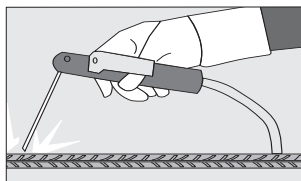

Svařování může negativně ovlivnit vlastnosti materiálu použitého pro HBT. Proto je svařování a vnášení tepla v oblasti zpětného ohnutí zakázáno. Mimo tuto oblast provádějte svařování pouze podle platných předpisů a na vlastní zodpovědnost.

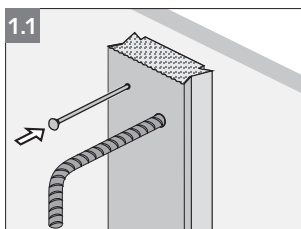

1.1 Podle plánu výztuže připevněte HBT na určeném místě hřebíky na bednění (jeden prvek - 3 hřebíky). U ocelového bednění použijte vhodné upevnění, např. magnetické držáky.

2. Po betonáží a odbednění: odstraňte krycí plech



Pozor! Nebezpečí poranění ostrými hranami krycího plechu. Použijte ochranné pracovní prostředky!

2.1 Odstraňte zbytky ztvrdlého betonu z plechu lehkým poklepem kladiva.

2.2 Do podélného výřezu krycího plechu zasuňte podélnou stranu krátkého hranolku. Na hranolek několikrát poklepejte kladivem, aby se krycí plech uvolnil od betonu.

2.3 Ostrou hranou kladiva vyrazte předem vyznačený otvor v krycím plechu a plech vytrhněte.

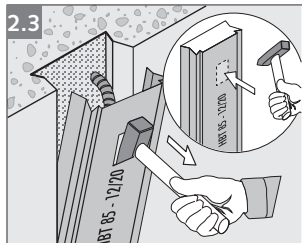
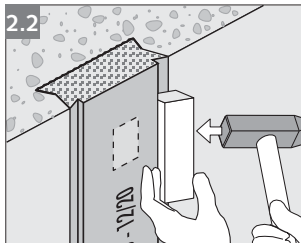
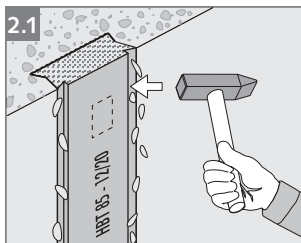

3. Zpětné ohnutí výztuže

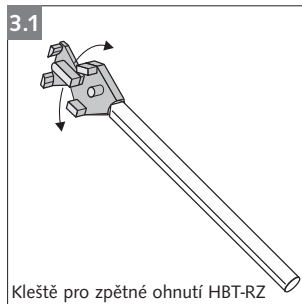

3.1 Kleštěmi HBT-RZ provedete zpětné ohnutí či narovnání prutů výztuže. Pro různé průměry prutů výztuže nabízí HALFEN dva typy kleští:

Typ	pro pruty:	Obj.č.
HBT-RZ 8/10	Ø 8 a 10 mm	0064.010-00001
HBT-RZ 10/12	Ø 10 a 12 mm	0064.010-00002

- Zpětné ohýbání výztuže bez vhodného nástroje není přípustné podle návodu „Zpětné ohýbání betonářské oceli a požadavky na úložné boxy podle eurokódu 2“ DBV (Deutscher Beton- und Bautechnik-Verein e.V.), oddíl 3. 2.(4).
- Zpětné ohýbání není přípustné při teplotách nižších než -5 °C.

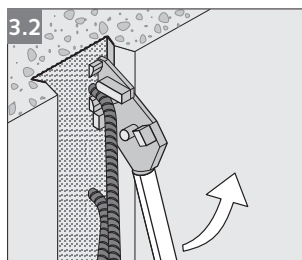

3.2 Nasadte kleště HBT-RZ na prut výztuže.

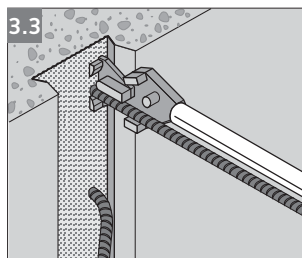

3.3 Oběma rukama rovnoměrně táhněte pákou nahoru, až se prut výztuže narovná bez zalomení do požadované polohy. Stejným způsobem postupujte u všech prutů prvku HBT. Profilovaný zadní kryt prvku HBT zůstává v betonu.

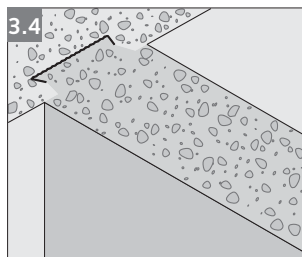

3.4 Po betonáži navazujícího stavebního dílce je zadní kryt HBT dokonale krytý betonem a chráněn proti korozi.



Upozornění! Krycí plechy likvidujte jako recyklovatelný plechový odpad.

English

Deutsch

Nederlands

Polski

Português

Česky

CONTACT HALFEN WORLDWIDE

HALFEN is represented by subsidiaries in the following 14 countries, please contact us:

Austria	HALFEN Gesellschaft m.b.H. Leonard-Bernstein-Str. 10 1220 Wien	Phone: +43-1-2596770 E-Mail: office@halfen.at Internet: www.halfen.at	Fax: +43-1-259-677099
Belgium / Luxembourg	HALFEN N.V. Borkelstraat 131 2900 Schoten	Phone: +32-3-6580720 E-Mail: info@halfen.be Internet: www.halfen.be	Fax: +32-3-6581533
China	HALFEN Construction Accessories Distribution Co.Ltd. Room 601 Tower D, Vantone Centre No.A6 Chao Yang Men Wai Street Chaoyang District Beijing · P.R. China 100020	Phone: +86-1059073200 E-Mail: info@halfen.cn Internet: www.halfen.cn	Fax: +86-1059073218
Czech Republic	HALFEN s.r.o. Business Center Šafránkova Šafránkova 1238/1 155 00 Praha 5	Phone: +420-311-690060 E-Mail: info@halfen-deha.cz Internet: www.halfen-deha.cz	Fax: +420-235-314308
France	HALFEN S.A.S. 18, rue Goubet 75019 Paris	Phone: +33-1-44523100 E-Mail: halfen@halfen.fr Internet: www.halfen.fr	Fax: +33-1-44523152
Germany	HALFEN Vertriebsgesellschaft mbH Katzbergstrasse 3 40764 Langenfeld	Phone: +49-2173-9700 E-Mail: info@halfen.de Internet: www.halfen.de	Fax: +49-2173-970225
Italy	HALFEN S.r.l. Soc. Unipersonale Via F.lli Bronzetti N° 28 24124 Bergamo	Phone: +39-035-0760711 E-Mail: info@halfen.it Internet: www.halfen.it	Fax: +39-035-0760799
Netherlands	HALFEN b.v. Oostermaat 3 7623 CS Borne	Phone: +31-74-267 1449 E-Mail: info@halfen.nl Internet: www.halfen.nl	Fax: +31-74-267 2659
Norway	HALFEN AS Postboks 2080 4095 Stavanger	Phone: +47-51823400 E-Mail: post@halfen.no Internet: www.halfen.no	Fax: +47-51823401
Poland	HALFEN Sp. z o.o. Ul. Obornicka 287 60-691 Poznan	Phone: +48-61-622 1414 E-Mail: info@halfen.pl Internet: www.halfen.pl	Fax: +48-61-622 1415
Sweden	Halfen AB Vådursgatan 5 412 50 Göteborg	Phone: +46-31-985800 E-Mail: info@halfen.se Internet: www.halfen.se	Fax: +46-31-985801
Switzerland	HALFEN Swiss AG Hertistrasse 25 8304 Wallisellen	Phone: +41-44-8497878 E-Mail: mail@halfen.ch Internet: www.halfen.ch	Fax: +41-44-8497879
United Kingdom / Ireland	HALFEN Ltd. A1/A2 Portland Close Houghton Regis LU5 5AW	Phone: +44-1582-470300 E-Mail: info@halfen.co.uk Internet: www.halfen.co.uk	Fax: +44-1582-470304
United States of America	HALFEN USA Inc. 8521 FM 1976 P.O. Box 547 Converse, TX 78109	Phone: +1 800.423.91 40 E-Mail: info@halfenusa.com Internet: www.halfenusa.com	Fax: +1 877 . 683.4910
For countries not listed	HALFEN International GmbH Liebigstr. 14	Phone: +49-2173-970-0 E-Mail: info@halfen.com Internet: www.halfen.com	Fax: +49-2173-970-849
HALFEN International	40764 Langenfeld / Germany		

Furthermore HALFEN is represented with sales offices and distributors worldwide.



Please contact us: www.halfen.com

NOTES REGARDING THIS DOCUMENT

Technical and design changes reserved. The information in this publication is based on state-of-the-art technology at the time of publication. We reserve the right to make technical and design changes at any time. Halfen GmbH shall not accept liability for the accuracy of the information in this publication or for any printing errors.

The Quality Management System of Halfen GmbH is certified for the locations in Germany, France, the Netherlands, Austria, Poland, Switzerland and the Czech Republic acc. to **DIN EN ISO 9001:2008**, Certificate No. QS-281 HH.



